



4"x4" Square Fiberglass Light Poles

Anchor Base

Standard and Heavy Duty

Product Offering Includes:

- 12'-25' Lengths.
- 3-Layers of protection against UV degradation. Includes thermally bonded outer coating.
- Anchor Base (Direct Bury also available).
- Anchor Base with 8.5"-9.5" Bolt Circle.
- Base Covers Available.
- Top Cap with drilled mounting holes, 2-3/8" and 3" Tenons coming soon.
- Standard Colors in black, bronze, or gray (other colors available by request).
- Smooth Finish.
- Light Weight, Non-Conductive, and Non-Corrosive.

Product Numbers and EPA Ratings

Standard Duty

Mounting Height	Catalog Number	Calculated Effective Projected Area (EPA) ^{1,2}							Weight of the Pole (lbs)
		90 mph	100 mph	110 mph	120 mph	130 mph	140 mph	150 mph	
12	A4SS12F00S##GXHH	17.0	13.1	10.3	8.1	6.6	6.2	4.9	37
15	A4SS15F00S##GXHH	12.3	9.2	6.9	5.1	3.8	3.5	2.5	44
18	A4SS18F00S##GXHH	8.6	6.0	4.1	2.6	1.6	1.3	-	51
20	A4SS20F00S##GXHH	6.5	4.2	2.4	1.2	-	-	-	56
22	A4SS22F00S##GXHH	4.6	2.5	1.0	-	-	-	-	61
24	A4SS24F00S##GXHH	3.0	1.1	-	-	-	-	-	66
25	A4SS25F00S##GXHH	2.2	-	-	-	-	-	-	69

Heavy Duty

Mounting Height	Catalog Number	Calculated Effective Projected Area (EPA) ^{1,2}							Weight of the Pole (lbs)
		90 mph	100 mph	110 mph	120 mph	130 mph	140 mph	150 mph	
12	A4SH12F00S##GXHH	35.2	27.9	22.5	18.4	15.4	14.7	12.4	63
15	A4SH15F00S##GXHH	27.1	21.2	16.8	13.4	11.0	10.4	8.5	81
18	A4SH18F00S##GXHH	20.9	16.0	12.3	9.5	7.6	7.1	5.5	91
20	A4SH20F00S##GXHH	17.3	13.0	9.7	7.3	5.5	5.1	3.7	100
22	A4SH22F00S##GXHH	14.3	10.4	7.5	5.3	3.7	3.4	2.1	109
24	A4SH24F00S##GXHH	11.7	8.2	5.6	3.6	2.2	1.8	0.7	119
25	A4SH25F00S##GXHH	10.6	7.2	4.7	2.8	1.5	1.1	-	123
30	A4SH30F00S##GXHH	5.0	2.0	-	-	-	-	-	150



Additional pole heights, wind zones, and EPAs available at alliancecompositesinc.com.

Catalog Number

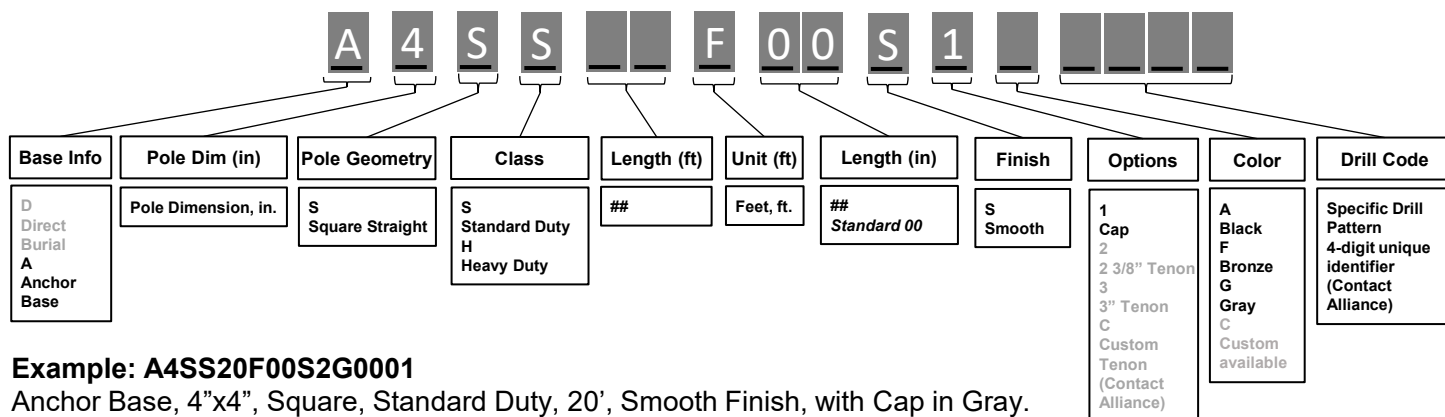

Example: A4SS20F00S1G0001

Anchor Base, 4"x4", Square, Standard Duty, 20', Smooth Finish, with Cap in Gray.

Pole Specifications

Pole Shaft

Composite poles are designed and pultruded using continuous glass fiber reinforcement within a thermoset resin matrix and include a durable and long-lasting thermally bonded UV coating. All square poles are manufactured in a state-of-the-art ISO9001 certified manufacturing facility ensuring a durable, long-lasting, and resilient product in all climates.

Finish³

Poles are available in a Smooth finish. All square poles include 3-layers of UV protection, including a thermally bonded outer coating. Colors include black, bronze, and gray.

Base Covers³

Square and Tapered Base Covers are available, color matched to the pole for the ultimate streamlined look.



Standard Base Cover
BC-SS-40-#

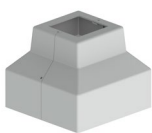

Tiered Base Cover
BC-ST-40-#

Hand Hole and Cover

Hand hole cover is 2.5"x5", UV resistant polymer, color matched to the pole. Hand hole is located 18" above ground level.

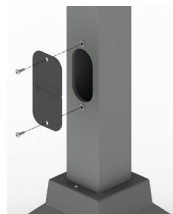

Mounting Options – Top Caps and Tenons

Plastic top cap is shipped, assembled to the pole. For top mount luminaires, Aluminum 2-3/8" and 3" diameter tenons coming soon.

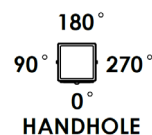

Drilling⁴

All poles are factory drilled to specifications outlined in the manufacturing drawing.

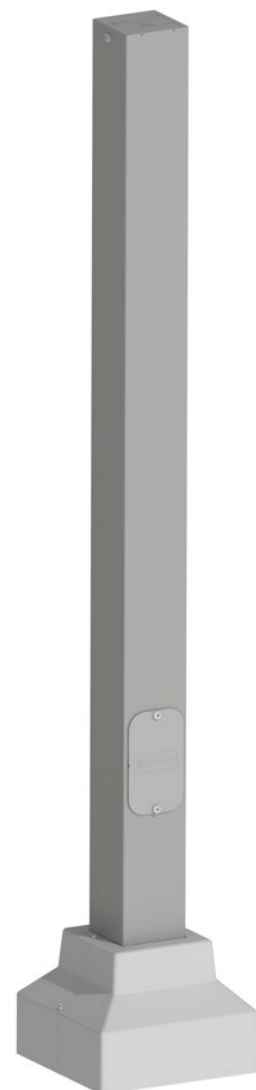
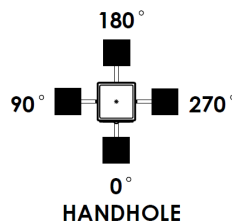

Pole Accessories³

Catalog Number	Description
BC-SS-4-0-5	Square Base Cover, Black
BC-SS-4-0-3	Square Base Cover, Bronze
BC-SS-4-0-2	Square Base Cover, Gray
BC-ST-4-0-5	Tapered Base Cover, Black
BC-ST-4-0-3	Tapered Base Cover, Bronze
BC-ST-4-0-2	Tapered Base Cover, Gray
HDWR-AP-AB08	3/4" x 18" x 3", F1554 grade 55 L-shape anchor bolts, 3.5" thread hot dip galvanized with (2) heavy hex nuts & (2) USS flat washers, kit of 4 bolts w/washers/nuts
HDWR-AP-AB09	3/4" x 24" x 3", F1554 grade 55 L-shape anchor bolts, 4" thread hot dip galvanized with (2) heavy hex nuts & (2) USS flat washers, kit of 4 bolts w/washers/nuts
HDWR-AP-AB10	3/4" x 30" x 4", F1554 grade 55 L-shape anchor bolts, 4" thread hot dip galvanized with (2) heavy hex nuts & (2) USS flat washers, kit of 4 bolts w/washers/nuts
HDWR-AP-AB11	3/4" x 36" x 4", F1554 grade 55 L-shape anchor bolts, 4" thread hot dip galvanized with (2) heavy hex nuts & (2) USS flat washers, kit of 4 bolts w/washers/nuts

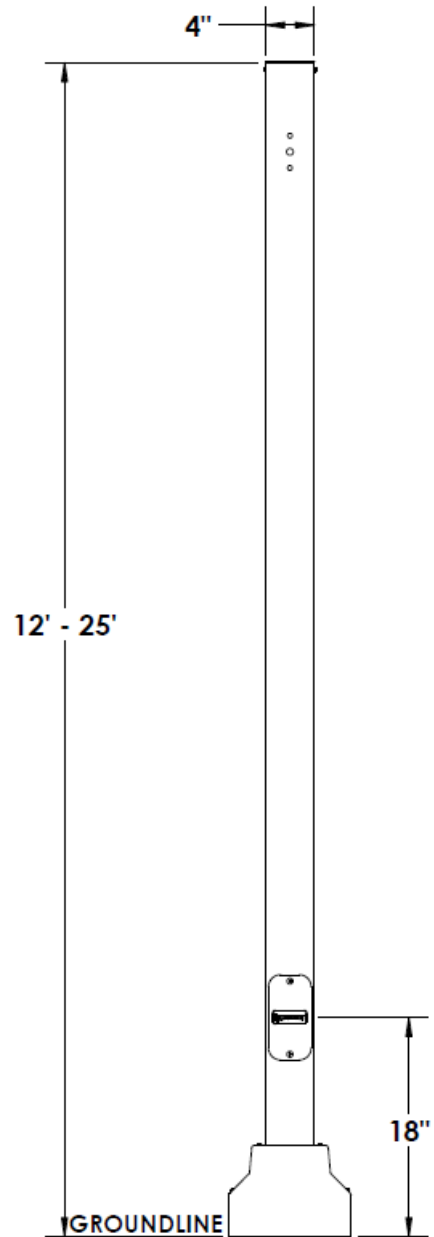

Anchor Base References⁵

Anchor Base

Bases are made from corrosion resistant aluminum material providing a light weight yet strong anchor base solution. Standard 8.5"-9.5" bolt circle range. Anchorage kits available. Direct burial poles also available.

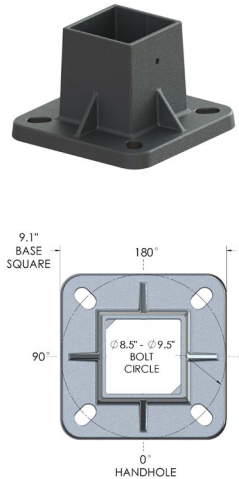
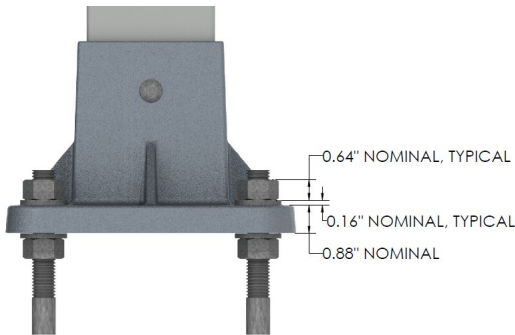

NOTES

¹Design criteria per AASHTO LTS-6-2013, with a minimum safety factor of 1.5 per ANSI C136.20-2012, 3 second gust wind speeds per ASCE 7-16, and velocity conversions per IBC 1609.3.1, 2018. Lighting installations for side and top mounting of luminaires with effective projected area (EPA) not exceeding maximum allowable loading of the specified pole in its installed geographic location. EPA ratings available up to 180 mph or for EPA ratings calculated per AASHTO LRFD or other, alternate methods, contact sales@alliancecompositesinc.com for more information.

²Always consult local authorities to determine maximum wind velocities, gusting and unique wind conditions for each specific application.

Allowable pole EPA for jobsite wind conditions must be equal to or greater than the total EPA for fixtures, arms, and accessories attached to the pole. Responsibility lies with the specifier for correct pole selection. Installation of poles without luminaires or attachment of any unauthorized accessories is discouraged and shall void the manufacturer's warranty.

Wind speeds and listed EPAs are for ground-level mounted installations only. Poles mounted on structures (bridges, buildings or other) must consider vibration and coefficient of height factors beyond this general guide. Consult all relevant local codes and federal standards. Extreme wind events like Hurricanes or Tornadoes may expose poles to flying debris, wind shear or other detrimental effects not included in wind velocity ratings.

³Longer lead times may apply, contact factory. # designates color, 2 = Gray, 3 = Bronze, 5 = Black. Custom colors available on request. Contact Alliance for information.

⁴Alliance™ is not responsible for luminaire to pole compatibility. Drill specifications, orientation and locations are provided by the customer and approved, prior to PO acceptance.

⁵Contractor is responsible for bolt selection depending on their individual criteria for the foundation of the anchor base per local code. Installation of Alliance poles on existing structures are the sole responsibility of the installer.

Contact Alliance engineers at alliance@geotek.com for pole design recommendations.

All specifications are subject to change without notice. Please visit alliancecompositesinc.com for latest information. Consult GEOTEK with specific inquiries.

GEOTEK
1421 Second Avenue, NW
Stewartville, MN 55976

All rights reserved. No part of this document may be reproduced in any form without the prior written permission of GEOTEK.

www.geotek.com
507-533-6076

Copyright © 2023, GEOTEK.